

Fuel Cell and Battery Electric Vehicles Compared

By C. E. (Sandy) Thomas*

H₂Gen Innovations, Inc., Alexandria, Virginia, 22304, USA

Abstract

Several alternative vehicle and fuel options are under consideration to alleviate the triple threats of climate change, urban air pollution and foreign oil dependence caused by motor vehicles. This paper evaluates the primary transportation alternatives and determines which hold the greatest potential for averting societal threats. We developed a dynamic computer simulation model that compares the societal benefits of replacing conventional gasoline cars with vehicles that are partially electrified, including hybrid electric vehicles, plug-in hybrids fueled by gasoline, cellulosic ethanol and hydrogen, and all-electric vehicles powered exclusively by batteries or by hydrogen and fuel cells. These simulations compare the year-by-year societal benefits over a 100-year time horizon of each vehicle/fuel combination compared to conventional cars. We conclude that all-electric vehicles will be *required* in combination with hybrids, plug-in hybrids and biofuels to achieve an 80% reduction in greenhouse gas emissions below 1990 levels, while simultaneously cutting dependence on imported oil and eliminating nearly all controllable urban air pollution from the light duty vehicle fleet. Hybrids and plug-ins that continue to use an internal combustion engine will not be adequate by themselves to achieve our societal objectives, even if they are powered with biofuels. There are two primary options for all-electric vehicles: batteries or fuel cells. We show that for any vehicle range greater than 160 km (100 miles) fuel cells are superior to batteries in terms of mass, volume, cost, initial greenhouse gas reductions, refueling time, well-to-wheels energy efficiency using natural gas or biomass as the source and life cycle costs.

Keywords:

Fuel cell electric vehicles
Hydrogen infrastructure
Plug-in hybrids
Greenhouse gases
Electric vehicles
Energy security

*Corresponding author. Tel.:703-461-7657;

E-mail address: thomas@cleancaroptions.com

This article was published in the International Journal of Hydrogen Energy 34 (2009) 6005-6020

doi:10.1016/j.ijhydene.2009.06.003

Fuel Cell and Battery Electric Vehicles Compared

Nomenclature

ABC	Advanced Battery Consortium	MPa	Mega-Pascal (unit of pressure)
CCS	Carbon capture and storage	NG	natural gas
CO	Carbon monoxide	NGV	natural gas vehicle
DOE	The United States Department of Energy	NiMH	nickel metal hydride (battery)
HEV	Hybrid electric vehicle (a vehicle with an internal combustion engine and an electric traction motor)	NOx	nitrous oxides
ICV	Internal combustion vehicle	NRC	National Research Council
EIA	Energy Information Administration (part of the DOE)	NRDC	Natural Resources Defense Council
EPA	Environmental Protection Agency	Pb-A	Lead acid (battery)
EPRI	Electric Power Research Institute	PEM	Proton exchange membrane (low-temperature fuel cell system favored for automotive applications)
EV	Electric vehicle	PM-2.5	particulate matter less than 2.5 microns in size
FC	Fuel cell	PM-10	particulate matter less than 10 microns in size
FCEV	Fuel cell electric vehicle	SI	spark ignition
PHEV	plug-in hybrid electric vehicle	SOC	state of charge
GHG	greenhouse gases	SOx	sulfur oxides
GREET	Greenhouse gases, Regulated Emissions and Energy use in Transportation (an Argonne National Laboratory computer program)	USABC	United States Advanced Battery Consortium
LDV	light duty vehicle (includes both passenger cars and light duty trucks)	VMT	vehicle miles traveled
Li-ion	lithium ion (battery)	VOC	volatile organic compounds
MBTU	million British thermal units	WECC	Western Electricity Coordinating Council
MIT	Massachusetts Institute of Technology	Wh	Watt-hour
		ZEV	Zero emission vehicle

could make a major contribution to achieving our long-term societal goals.

1. Introduction

New fuels and alternative vehicles will be required to substantially cut our dependence on foreign oil and reduce our transportation sector carbon footprint. Biofuels such as biodiesel, ethanol or butanol, especially if made from cellulosic feedstocks, are promising. Natural gas can reduce oil consumption and make modest reductions in greenhouse gas emissions, but is only a temporary transition fuel at best. Hydrogen and electricity could eventually become our primary zero-carbon transportation fuels.

In terms of alternative vehicles, gasoline-powered hybrid electric vehicles (HEVs) are already making a small impact in the light duty vehicle fleet, and plug-in hybrid electric vehicles (PHEVs) that derive some of their energy by charging batteries from the electrical grid may soon enter the marketplace. The combination of biofuels and PHEVs will reduce oil consumption, and--depending on the types of fuels used at power plants to generate electricity in any region--may help to appreciably reduce greenhouse gas emissions. Ultimately all-electric vehicles powered either by fuel cells or by batteries

The 2008 National Research Council (NRC) report on alternative transportation technologies compared advanced gasoline internal combustion vehicles with gasoline HEVs, biofuels and hydrogen-powered fuel cell electric vehicles (FCEVs) [1]. They first considered each fuel or technology acting alone. The NRC showed that biofuels by themselves or advanced gasoline internal combustion engine cars by themselves would each reduce greenhouse gas (GHG) emissions and oil consumption compared to business as usual, but both emissions and oil use would level off or begin rising again after 2030 as increased vehicle miles traveled substantially cancelled out the advantage of biofuels or advanced engine technologies. The NRC report showed that hydrogen-powered FCEVs, acting alone, would set GHG emissions and oil consumption on a steady downward trajectory. So if society opted for only one pathway and GHG reductions was the primary goal, then the NRC data show that hydrogen FCEVs would be the most beneficial option in the long run.

Fuel Cell and Battery Electric Vehicles Compared

The best outcome, however, would rely on a portfolio of fuels and technologies. The NRC concluded that biofuels, HEVs, advanced gasoline engines and hydrogen-powered FCEVs, acting together, will be required to eliminate nearly all oil consumption from cars and to cut GHGs to 80% below 1990 levels by 2050....we need all of the above.

Our detailed computer simulations show similar results [2,3]. We analyzed five major vehicle/fuel scenarios over the 21st century in addition to a reference case with only gasoline internal combustion vehicles (ICVs):

- Gasoline-powered hybrid electric vehicles added to the gasoline ICV mix
- Gasoline-powered PHEVs added to the HEVs and ICVs
- Ethanol-powered PHEVs added to HEVs and ICVs
- Hydrogen-powered fuel cell EVs added to ethanol PHEVs, gasoline HEVs and ICVs
- Battery-powered EVs added to ethanol PHEVs, gasoline HEVs and ICVs

In these scenarios the alternative vehicles are added to the existing mix of vehicles over the century as illustrated in Figure 1 for the FCEV scenario. Gasoline cars, HEVs and ethanol PHEVs dominate the new car sales in the first half of the century, with hydrogen-powered FCEVs reaching 50% market share by mid-century. The battery EV scenario has the same new car sales mix as the FCEV scenario but with battery EVs replacing the FCEVs.

We conclude from our detailed simulations that all-electric vehicles in combination with biofuels, HEVs and PHEVs will most likely be required to meet our energy security and climate change reduction goals [2,3]. As shown in Figure 2, hybrid electric vehicles (HEV's) and plug-in hybrid electric vehicles (PHEV's) both reduce GHG emissions, but these vehicles that still use internal combustion engines will not be adequate to cut GHGs to 80% below 1990 levels,

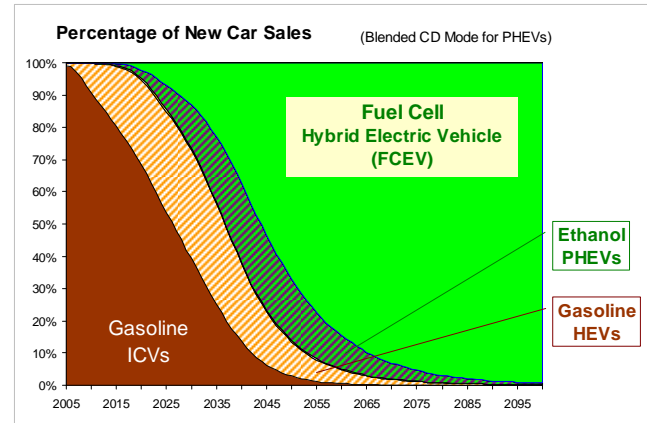

Figure 1. Percentage of new cars sold over the 21st century for the hydrogen-powered fuel cell electric vehicle (FCEV) scenario, showing the mixture of gasoline internal combustion engine vehicles (ICVs), followed by gasoline-powered hybrid electric vehicles (HEVs), (cellulosic) ethanol-powered plug-in hybrid electric vehicles (PHEVs) and finally the hydrogen-powered FCEVs.

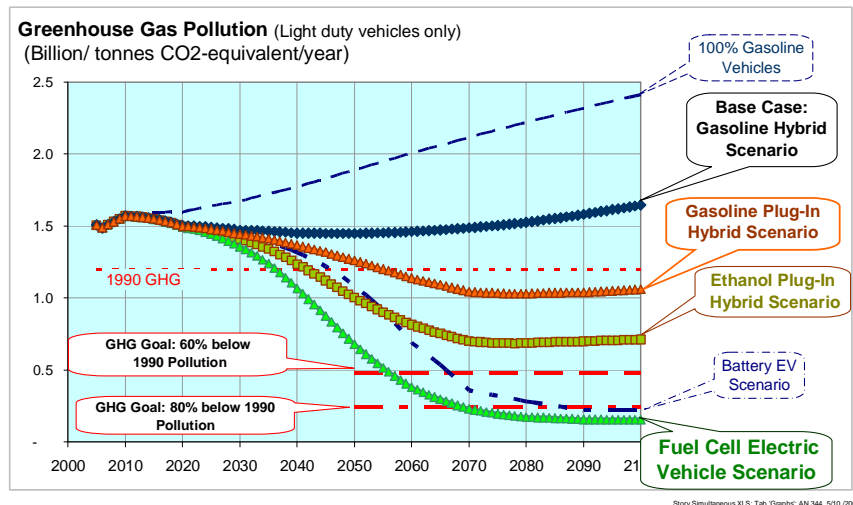

Figure 2. Projected greenhouse gases for different alternative vehicle scenarios over the 21st century for the US light duty vehicle fleet, assuming that both the electrical grid and hydrogen production reduce their carbon footprints over time. (EV= electric vehicle)

the goal set by the climate change community, even if biofuels such as cellulosic ethanol are used in place of gasoline to power the internal combustion engines on the PHEVs. Only by gradually adding hydrogen-powered FCEVs or battery EVs to the mix over the century can we substantially curb GHG emissions.

Fuel Cell and Battery Electric Vehicles Compared

Similarly, Figure 3 shows that HEV's and PHEV's powered by biofuels will be unlikely to reduce oil consumption in the US to levels that would allow

attention than climate change or oil dependence, the costs of air pollution will increase with any of the scenarios that still include the internal combustion engine as shown in Figure 4.

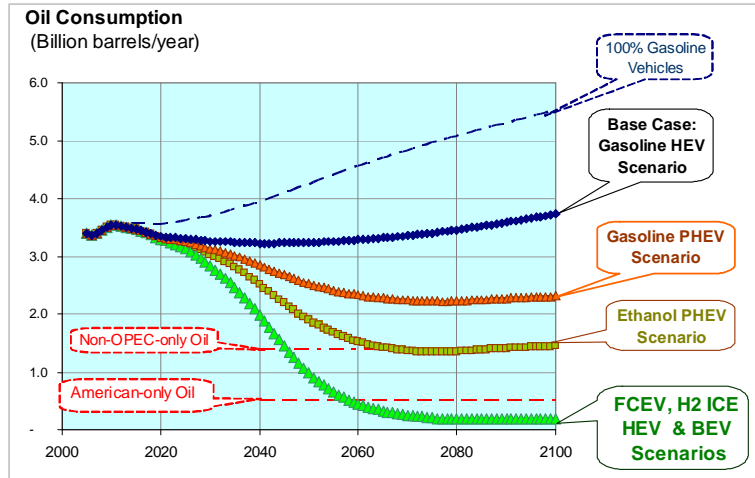

Figure 3. Oil consumption from US light duty vehicles over the 21st century for different alternative vehicle scenarios

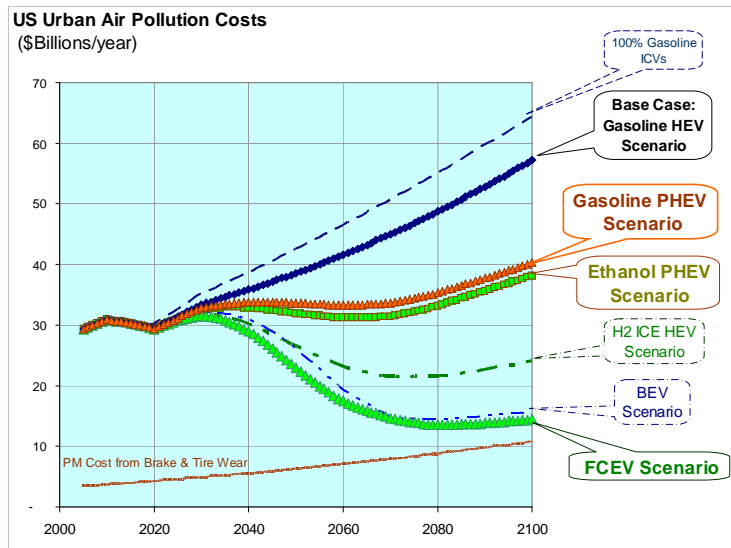

Figure 4. Estimated societal costs of urban air pollution for the alternative vehicle scenarios over the 21st century (PM = particulate matter)

us to produce most of our petroleum from American sources if needed in a crisis. While urban air pollution¹ currently receives less

¹ The costs of monetizing urban air pollutants were derived from averaging six sources from the literature [3] resulting in the following costs in \$/metric tonne: PM-10: \$1,608; PM-2.5: \$134,047; SOx: \$29,743; VOC: \$6,592; CO: \$1,276; and NOx: \$13,844.

To achieve oil “quasi-independence,” to cut GHGs to 80% below 1990 levels, and to remove most urban air pollution from cars and trucks, we will eventually have to eliminate the internal combustion engine from many if not most light duty vehicles. We will have to transition to all-electric vehicles over the next few decades to meet our societal goals, in conjunction with HEVs, biofuels and PHEVs in the near term.

We currently have only two primary choices to power all-electric vehicles: fuel cells or batteries. Both generate electricity to drive electric motors, eliminating the pollution and inefficiencies of the venerable internal combustion engine. Fuel cells derive their energy from hydrogen stored on the vehicle, while batteries obtain all of their energy from batteries that were charged by the electrical grid. Both hydrogen and electricity can be made from low- or zero-carbon sources including renewable energy (solar, wind & biomass), nuclear energy and coal with carbon capture and storage (CCS). Both hydrogen and electricity are zero carbon fuels that will permit all-electric vehicles to meet the stringent California zero emission vehicle (ZEV) standards, eliminating virtually all controllable² urban air pollution from light duty motor vehicles.

2. Fuel Cell and Battery Comparisons

In the following sections, we compare hydrogen-powered fuel cell electric vehicles (FCEV's) with battery-powered electric vehicles (BEV's) in terms of mass, volume, greenhouse gases, fueling time, energy efficiency, fueling infrastructure and cost.

² All-electric cars will still generate some particulate matter (PM) from tire and brake wear, but there are no tailpipe emissions.

Fuel Cell and Battery Electric Vehicles Compared

2.1. Vehicle Mass

Figure 5 compares the *useful* specific energy (energy per unit mass) of current deep discharge lead-acid (Pb-A) batteries, nickel metal hydride (NiMH), advanced lithium-ion (Li-ion) batteries and the US ABC (Advanced Battery Consortium) goal with the specific energy of a PEM fuel cell system that includes compressed hydrogen storage tanks and peak power batteries used to capture regenerative braking and to boost power on a FCEV. Two hydrogen pressures are shown: 35 MPa (350 bar or 5,000 psi) and 70 MPa (700 bar or 10,000 psi) with fiber-wrapped composite tanks. The 70 MPa tanks weigh more than the 35 MPa tanks due to the requirement for extra fiber wrap to provide the needed strength³. The energy plotted on this graph is the actual *useful* energy delivered to the vehicle motor controller, not the total stored energy. For hydrogen, we calculate only the electrical energy out of the fuel cell system, which is approximately 52% of the lower heating value of the hydrogen stored in the compressed gas tanks, averaged over an aggressive vehicle driving cycle. The mass in the specific energy calculation includes the hydrogen tanks, a high power battery pack to capture regenerative braking and boost acceleration, and the fuel cell stack plus all auxiliary fuel cell system components such as humidification, air blowers and control electronics. Similarly, for batteries we

include only the energy delivered to the motor in the specific energy calculation, not the total stored battery energy. For example, a battery pack might store 200 Wh/kg of energy, but if the state of

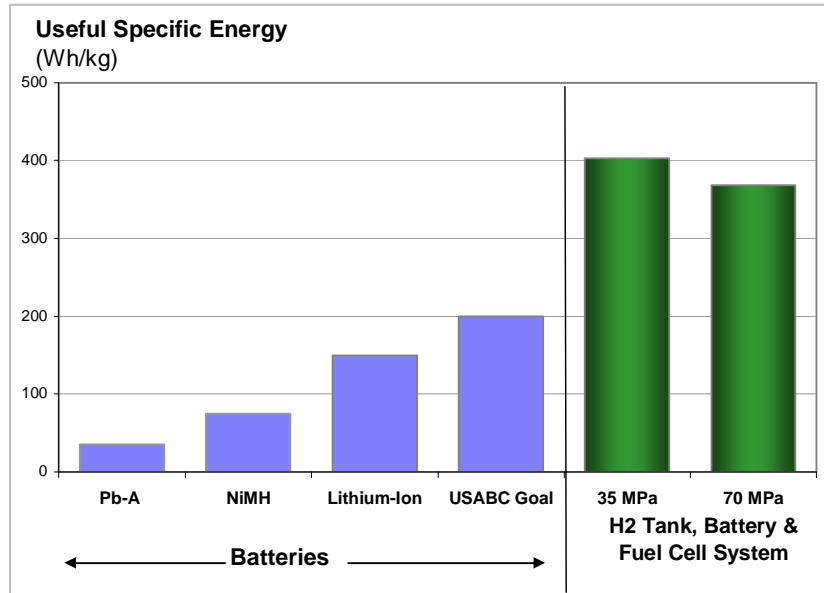

H2Gen: WT_Vol_Cost.XLS: Tab 'Battery'; S60 - 4 / 27 / 2009

Figure 5. The useful specific energy (energy per unit mass) of hydrogen and fuel cell systems (including a peak power battery) compared to the useful specific energy of various battery systems

charge (SOC) can only be varied between 20% and 90% to avoid battery degradation over time, then the useful specific energy would be less than 140 Wh/kg⁴. The mass used to calculate specific energy includes all battery system components such as thermal management systems, the onboard battery charger and associated electronic controls.

Figure 5 illustrates that compressed hydrogen powering a fuel cell can provide electricity to a vehicle traction motor with five times more energy per unit mass than current NiMH batteries used in most gasoline HEVs, and two times more than advanced Lithium-ion batteries and the US ABC goal. As a result, battery EVs must be heavier than FCEVs for a given range, as shown in Figure

³ The compressed hydrogen tanks and fuel cell data are based on the following parameters: fuel cell power of 60 kW, current FC system specific power of 0.69 kW/kg [4], FC system power density of 0.67 kW/liter [4], 51.8% FC system efficiency averaged over the EPA 1.5 times accelerated combined driving cycle, 4.5 kg of useable onboard hydrogen storage for 350 miles range, 2.25 safety factor on the hydrogen tank, and a 1.7 times mass multiplier to account for current tank construction that is 70% heavier than minimum theoretically possible. With these data hydrogen is 5.9% of the mass of the 35 MPa tanks and 4.7% of the mass of the 70 MPa tanks.

⁴ Internal battery resistance will also reduce energy delivered to the motor as a result of I^2R losses, particularly at high current discharges when high power is required for vehicle acceleration.

Fuel Cell and Battery Electric Vehicles Compared

6 that is based on a full-function, five-passenger sedan⁵.

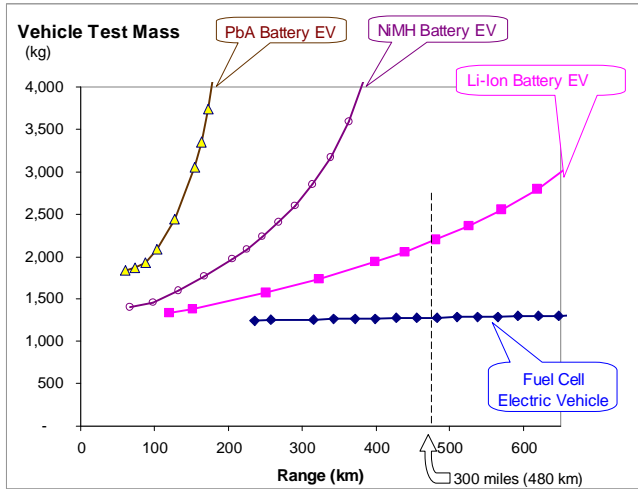

Figure 6. Calculated mass of fuel cell electric vehicles and battery electric vehicles as a function of the vehicle range; the powertrains of all vehicles are adjusted to provide a zero to 97 km/hr (60 mph) acceleration time of 10 seconds

Extra mass to increase the range of the fuel cell EV is negligible since hydrogen plus slightly larger tanks to extend the range adds little mass, while the battery EV mass escalates significantly with range, since each extra mile requires the addition of heavy battery plates. The non-linear growth in mass with vehicle range is the result of mass compounding, where each extra kilogram of battery to increase range requires extra structural mass, heavier brakes, a larger traction motor, and in turn more batteries to accelerate this extra mass in an insidious feedback process.

2.2. Storage Volume

Some analysts are concerned about the volume required for compressed gas hydrogen tanks on a FCEV. They do take up more space than a gasoline tank, but compressed hydrogen tanks plus the fuel cell system together take up *less* space than batteries per unit of useful energy delivered to the motor. Adding space needed for a peak power battery on the FCEV makes the system useful energy densities almost equal to the advanced Li-ion battery with 35-MPa storage tanks

⁵ Based on a FCEV with 560 km (350 miles) range with a test mass of 1280 kg, cross sectional area of 2.13 m², drag coefficient of 0.33 and rolling resistance of 0.0092.

as shown in Figure 7, while 70-MPa tanks preferred by the auto companies will have higher energy density.

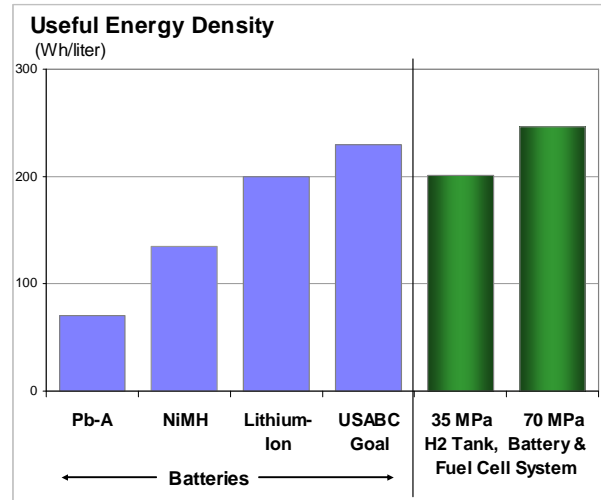

Figure 7. Useful energy densities (energy per unit volume) of hydrogen tanks and fuel cell systems compared to the useful energy densities of various battery systems

The total volume required for the hydrogen tanks and fuel cell system is compared with battery packs in Figure 8, again as a function of range. Since the battery EV weighs more than the FCEV for ranges greater than 80 km (50 miles), a long-

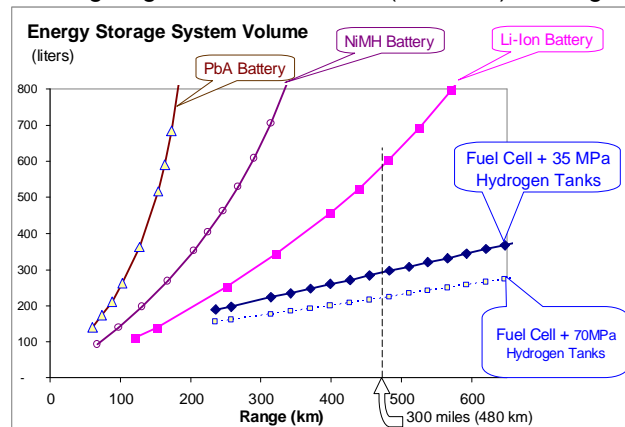

Figure 8. Calculated volume of hydrogen storage plus the fuel cell system compared to the space required for batteries as a function of vehicle range (the fuel cell system is included in the storage volume since the hydrogen tank plus the fuel cell system is required to match the function of the battery bank: to produce electricity for the electric motor)

range BEV requires more onboard energy storage to travel a given distance, requiring more space on the car despite the two systems having nearly

Fuel Cell and Battery Electric Vehicles Compared

identical useful energy densities. The space to store lead acid batteries would preclude a full five-passenger vehicle with a range of more than 160 km (100 miles), while a NiMH EV would be limited in practice to less than 240 km (150 miles) range.⁶

An EV with an advanced Li-Ion battery could in principle achieve 400 to 480 km (250 to 300 miles) range, but these batteries would take up 450 to 600 liters of space (equivalent to a 120 to 160 gallon gasoline tank!). The fuel cell plus hydrogen storage tanks would take up approximately half this space.

2.3. Greenhouse Gas Pollution

The greenhouse gas (GHG) implications of charging battery EVs with the electrical grid in the 2010 to 2020 time period will be serious in most parts of the country⁷. Since on average 52% of our electricity in the US comes from coal, and since the electrical grid efficiency averages only 35%⁸, GHGs would be greater for EVs in most parts of the US than for hydrogen-powered FCEVs in the early start-up years, assuming that most hydrogen was made by reforming natural gas for the next decade or two.

Increasing the mass of the EV by adding batteries to achieve reasonable range increases fuel

consumption as the vehicle becomes heavier, thereby generating more GHGs from the electrical power plant per mile driven. The GHG emissions with today's marginal grid mix are shown in Figure 9. These GHG calculations include all "well-to-wheels" GHGs adjusted for a 100-year atmospheric lifetime, based on the Argonne National Laboratory GREET model [6].

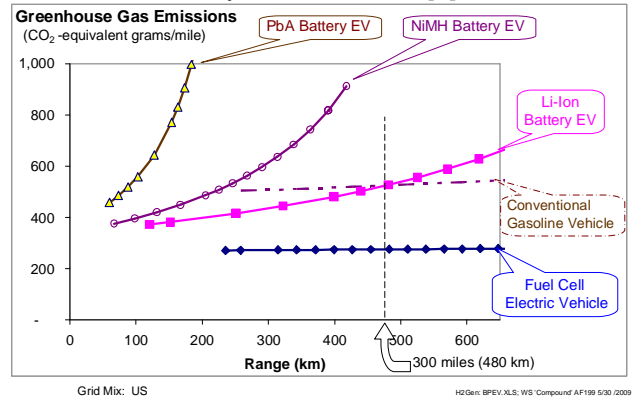

Figure 9. Estimated well-to-wheels greenhouse gas emissions as a function of vehicle range for the average US marginal grid mix in the 2010-2020 time period; all hydrogen is made from natural gas for this figure, which represents greenhouse gases for the next decade or two before the carbon footprint of electricity or hydrogen production is significantly reduced

Because longer range EVs are heavier and less efficient for any given battery type, a 5-passenger Pb-A battery EV that achieved more than 100 to 110 km (60 to 70 miles) range would generate more net GHGs than the gasoline version of the same car. A NiMH battery EV with more than 200 to 240 km (125 to 150 miles) range and an advanced Li-ion battery EV with more than 430 km (270 miles) range would generate more GHG emissions than a comparable gasoline car. Longer range battery EVs are possible⁹, but only by generating more GHGs than gasoline cars of the same size.

The hydrogen FCEV running on hydrogen made from natural gas can achieve the 480 to 560 km (300 to 350 mile) range demanded by American drivers with consistent GHG reductions. The gasoline ICE version the passenger vehicle analyzed here produces about 550 g/mile of CO₂-equivalent emissions according to the GREET

⁶ The battery EV range could be extended by reducing its mass, aerodynamic drag and rolling resistance as in the GM Impact/EV-1. But the FCEV range would also be increased with such a light, aerodynamic vehicle. The relative comparisons between FCEVs and BEVs in these charts would still be valid.

⁷ We expect that the electrical grid carbon footprint will be reduced with the introduction of some type of carbon tax or cap and trade system. But this will take at least a decade or two before coal plants can either be fitted with carbon capture and storage (CCS) systems or replaced by nuclear power and renewables. The GHGs estimated here apply only to the initial period when FCEVs or BEVs are first introduced. Our model assumes that lower carbon grid sources are phased in over the century, as reflected by the decreasing GHGs over time for BEVs in Figure 2.

⁸ Electrical power generating plants currently convert only 32% to 36% of the energy in coal to electricity, and, with electrical transmission line losses, only 92% of that electricity reaches the end user, or net system efficiency of conversion between 30% to 34% [5]. Natural gas conversion rates vary between 26% to 32% for gas turbines, and between 38% to 45% for combined cycle plants, or a net rate of converting natural gas to electricity between 24% to at most 42% [5].

⁹ Assuming that the added mass, volume, cost and longer fueling time of the battery banks were acceptable to consumers.

Fuel Cell and Battery Electric Vehicles Compared

model, so the FCEV powered by hydrogen made from natural gas would immediately cut GHG emissions by approximately 47% compared to gasoline cars.

Greenhouse gas emissions will be less than the average shown in Figure 9 in some regions of the country. California, for example, uses coal to generate only 13% of its electricity (imported from outside the state), compared to 52% for the national average. Approximately 40% of California's electricity comes from natural gas that produces lower GHGs than coal, and natural gas is the marginal generator option much of the time. As a result, GHGs are much less for a battery EV in California as shown in Figure 10. Advanced lithium-ion battery EVs with 320 km (200 miles) range are projected to have approximately the same GHGs as fuel cell EVs initially when hydrogen is made from natural gas.

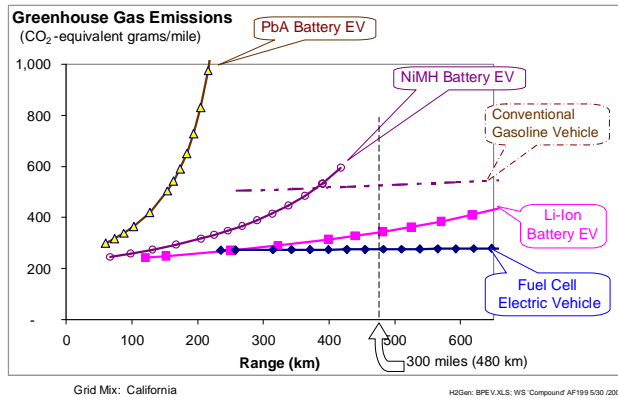

Figure 10. Estimated greenhouse gas emissions for battery EVs in California in the 2010-2020 time period compared to fuel cell EVs running on hydrogen made from natural gas

2.4. Fueling Time

Hundreds of thousands of high pressure natural gas-powered vehicles (NGVs) are refueled every day around the world, using technology comparable to high pressure hydrogen gas fueling systems. The National Renewable Energy Laboratory (NREL) has monitored the on-road performance of 140 FCEVs for several years [8]. The average refueling time was 3.3 minutes for 16,300 separate fueling episodes (2,000 at 70 MPa and 14,300 at 35 MPa).

Charging batteries for an all-electric vehicle will take much longer. One of the challenges facing

battery companies is to design and manufacture batteries that can accept rapid charging currents without overheating the battery cells or disrupting the voltage balance between cell banks. But even if batteries can be built to accept rapid charging, the local electrical supply system may still limit charging times for long-range BEVs. Residential electrical circuits are typically limited to less than 2 kW power for a 120 Volt, 20 Amp circuit (called Level 1 charging in the EV business), and special 240 Volt, 40 Amp, single phase circuits (Level 2 charging) used for dryers and electric stoves are limited to 8 kW¹⁰. A 5-passenger battery EV designed to achieve 320 km (200 miles) range might need to draw 82 kWh of energy from the electrical outlet (of which 74 kWh would be stored in the car battery after charging losses). A Level 1 residential charging circuit would then require more than 42 hours to fully charge a 320-km range BEV, and a Level 2 circuit would require at least 11 hours¹¹.

Higher power charging circuits are feasible in a commercial setting. Morrow et al. at the Idaho National Laboratory report that Level 3 fast charging outlets can provide 60 to 150 kW of power [9]. But even at these very high power levels, it would still take from 36 minutes to 1.4 hours to fully charge a 320-km BEV battery bank, and 1 to 2.5 hours to charge a 480-km (300-mile) advanced Li-ion battery bank (assuming that the batteries could accept 60 to 150 kW charging rates without deterioration.) Minimum estimated charging times are summarized in Table 1 for these hypothetical long-range BEVs.

¹⁰ The National Electrical Code requires that the building circuit be rated at least 125% above the maximum power draw for the battery charger [9].

¹¹ These charge time calculations assume a constant power draw; the charging times may be longer to accommodate a variable charging profile, along with periodic equalization charges.

Fuel Cell and Battery Electric Vehicles Compared

Table 1. Estimated refueling times for battery and fuel cell electric vehicles

Vehicle Range (km)	Battery Electric Vehicles					Fuel Cell EVs
	Energy Required from Grid (kWh)	Level 1 Charging Time (hours)	Level II Charging Time (hours)	Level III Charging Time (hours)		Hydrogen Tank Filling Time (hours)
		120V, 20A 1.9 kW	240 V, 40A 7.7 kW	480V, 3Φ 60 kW 150 kW		
241	56	29.2	7.3	0.9	0.4	0.08
322	82	42.7	10.68	1.4	0.55	0.10
483	149	77.6	19.40	2.5	0.99	0.15

2.5. Vehicle Cost

Kromer and Heywood at MIT have analyzed the likely costs of various alternative vehicles in mass production [10]. They conclude that an advanced battery EV with 320 km (200 miles) range would cost approximately \$10,200 more than a conventional car, whereas a FCEV with 560 km (350 miles) range is projected to cost only \$3,600 more in mass production. Plug-in hybrid electric vehicles (PHEVs) with only 16 km (10 miles) all-electric range would cost less than the FCEV (Figure 11), but plug-in hybrids with 100 km (60 miles) range are projected to cost over \$6,000 more than conventional gasoline cars. If we extrapolate the Kromer and Heywood data for BEVs to 480 km (300 miles) range, then the BEV would cost approximately \$19,500 more than a conventional car in mass production.

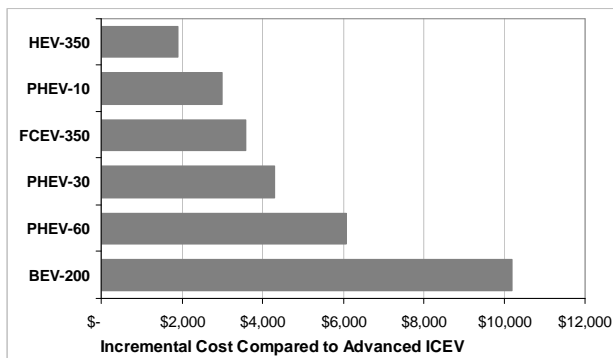

Figure 11. Estimated mass production incremental cost of hybrid and electrical vehicles compared to a conventional gasoline internal combustion engine vehicle [10] (numbers indicate total range in miles for the HEV, FCEV and BEV, and the all-electric range for PHEVs)

2.6. Fuel Cost

The cost of vehicle fuel (electricity or hydrogen) per km driven will depend on the fuel price per unit energy and the vehicle fuel economy. The residential price of electricity is projected by the DOE's Energy Information Administration in their 2009 Annual Energy Outlook to be approximately 10.8 cents/kWh during the 2012-2015 period, which corresponds to \$31.64/MBTU [11]. The NRC estimates that hydrogen will cost approximately \$3.30/kg by the time of hydrogen fueling system breakeven (Table 6.6 [1]) or \$29.05/MBTU. So costs of fuel per unit energy will be comparable once the hydrogen infrastructure is in place. Initially, without government subsidies, hydrogen costs would be much greater before there are enough FCEVs on the road to provide energy companies a reasonable return on investment. In addition, many BEV owners may receive lower off-peak electricity rates if they charge their batteries at night. As shown in Table 2, the cost per mile for a BEV owner with off-peak rate of 6 cents/kWh will be approximately half the cost of hydrogen fuel per km for a FCEV owner.

Table 2. Estimated fuel cost (cents per kilometer) for battery EV drivers and fuel cell EV drivers

Range (km)	Electricity		Hydrogen
	6 cents/kWh Off-Peak	10.8 c/kWh Residential	\$3.30 /kg
161	1.37	2.47	3.33
241	1.41	2.54	3.35
322	1.53	2.75	3.36
402	1.67	3.00	3.38
483	1.85	3.34	3.40

This lower fuel cost when off-peak rates are available would help to offset the higher initial price of the BEV. But the buyer of a 320-km (200-mile) BEV would still pay \$1,042 more for that vehicle

Fuel Cell and Battery Electric Vehicles Compared

including off-peak electricity at 6 cents/kWh to run it for 15 years than the purchaser of a 560-km (350-mile) range FCEV would pay including 15 years of hydrogen fuel. A buyer of a 480-km (300-mile) BEV would spend \$11,315 more over 15 years¹².

2.7. Fueling Infrastructure Cost

The 2008 National Research Council report estimated that a hydrogen fueling station based on reforming natural gas would cost approximately \$2.2 million when produced in quantities of 500 or more (Table 6.4 [1]). This station would support approximately 2,300 FCEVs¹³, so the average infrastructure cost per FCEV would be \$955. The initial stations will cost more, on the order of \$4 million each, which represents a per vehicle cost of \$1,700 when FCEVs are first introduced.

Adding a residential Level 1 (120V, 20A) charging outlet is estimated to cost \$878 by Idaho National Laboratory (page 32 [9]), but this capacity would require charging times of 43 hours for 320-km range and 78 hours for 480-km range. A higher capacity Level 2 outlet (240V, 40A) would cost about \$2,150 for a home residence and \$1,850 for a commercial outlet. This would reduce charging times to 11 hours for 320-km range, and 19 hours for 480-km range. A residential charging outlet could in principle be used to charge two or more BEVs, since only one BEV in a family would likely to be required to travel the longer distances in a particular period of a day or two. A Level 2 commercial outlet would most likely be unable to service more than one or two BEVs in a business day. The expected capital costs for long-range BEV charging outlets therefore varies between \$880 to \$2,100 per BEV.

While the capital costs per vehicle are comparable once fueling systems are deployed, more drivers could have access to electricity initially than access to hydrogen fueling stations. An individual BEV owner able to pay \$2,100 for a Level 2 home charging outlet fixture will be able to utilize his or her car within half the vehicle range from home

even if no other driver has a BEV in the area. A driver contemplating the purchase of a FCEV, however, would generally require at least one hydrogen fueling station within five or ten kilometers of home. Most potential FCEV owners could not afford his or her own hydrogen fueling station¹⁴. We assume that some combination of government and private investment would supply the capital to build the initial batch of hydrogen fueling stations, starting in clusters around a group of major metropolitan cities. Governments would be motivated to jump-start the hydrogen fueling systems to reap the huge societal benefits that will follow from the introduction of large numbers of zero-emission fuel cell EVs. Private investors will eventually be motivated to build new hydrogen fueling stations since the return on investment will be very lucrative once there are many FCEVs on the road.

3. Well-to-Wheels Energy Efficiency

3.1. Natural Gas Utilization

Efficiency

Suppose we have one million btu's of natural gas to power a motor vehicle. What is more efficient: to convert that natural gas to electricity in a central power plant to charge a battery EV, or to convert that natural gas to hydrogen to run a fuel cell electric vehicle?

Figure 12 illustrates the answer: one would need to burn approximately 1.29 million btu's (MBTU) of natural gas in a combustion turbine to generate the electricity needed to power a battery EV for 400 km (250 miles) on the EPA's 1.25X accelerated combined driving cycle. For a more efficient combined cycle gas turbine electricity generator system, 0.86 MBTU's of natural gas would be required. But only 0.67 MBTU's of natural gas would be sufficient to generate enough hydrogen to power a fuel cell EV for 400 km¹⁵.

¹² Both calculations assume 20,900 km (13,000 miles) traveled per year and zero discount rate; the cost differential would be even higher for drivers that discount future fuel savings.

¹³ Assuming 4.5 kg hydrogen to travel 560 km (350 miles) in a FCEV, 1,500 kg/day of hydrogen capacity, 70% average station capacity factor, and 20,900 km traveled per year per FCEV.

¹⁴ Although Honda and Plug Power are developing a hydrogen home fueling system, the cost may be too high for many FCEV owners.

¹⁵ Both electric vehicles are full-function 5-passenger vehicles with high acceleration [0 to 97 km/hr (60 mph) in 10 seconds], 0.33 drag coefficient, 2.13 square meters cross section and 0.0092 rolling resistance.

Fuel Cell and Battery Electric Vehicles Compared

On a full-cycle well-to-wheels basis, the hydrogen-powered fuel cell electric vehicle would use

Figure 12. Comparison of the amount of natural gas required to propel an advanced Li-ion battery EV 400 km (250 miles) using electricity compared to a fuel cell EV traveling 400 km using hydrogen based on 2010-2020 technology; the hydrogen-powered fuel cell EV consumes 22% to 48% less energy to travel 400 km.

Fuel Cell and Battery Electric Vehicles Compared

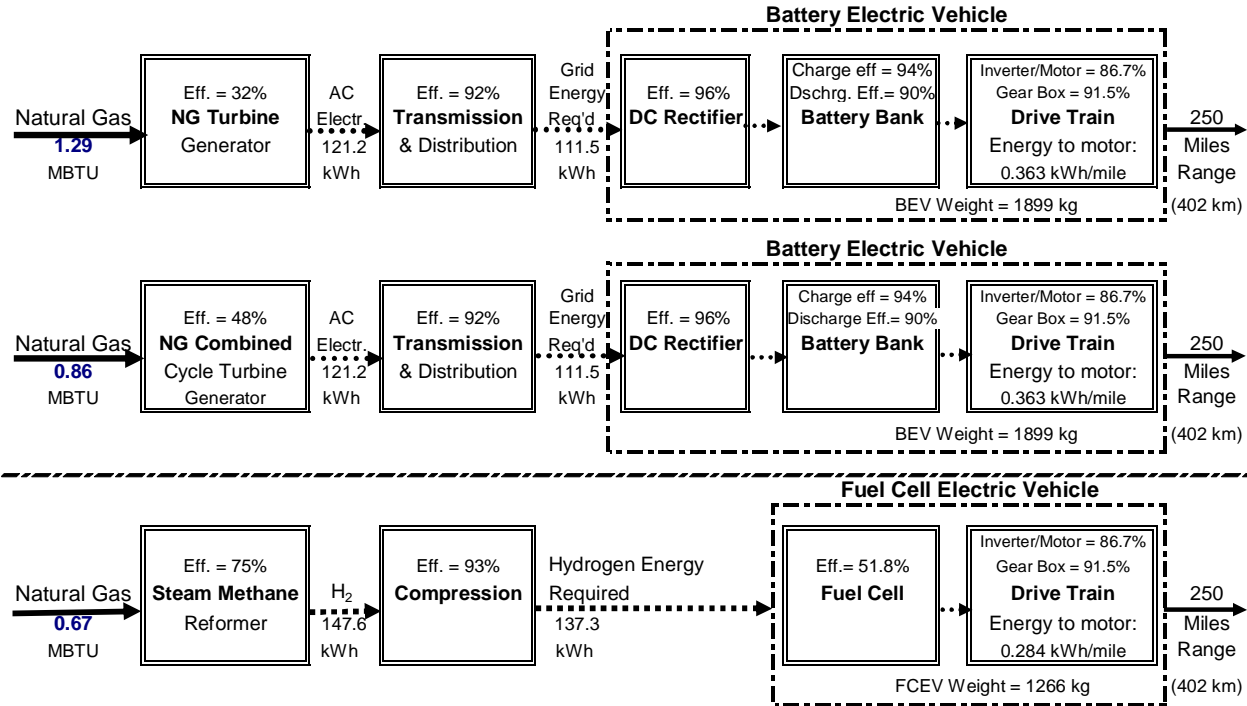

between 22% to 48% less energy than a battery EV in converting natural gas to vehicle fuel for 400-km travel range with existing electrical power plants¹⁶. This fuel cell EV advantage grows to between 33% and 55% less natural gas energy consumed for 480-km (300-mile) range vehicles.

This improved well-to-wheels energy efficiency of the fuel cell electric vehicle is due to the higher efficiency of converting natural gas to hydrogen compared to converting natural gas to electricity. A steam methane reformer converts natural gas to hydrogen with approximately 75% efficiency. Current natural gas combined cycle power plants have at best 48% efficiency in converting natural gas to electricity, and simple natural gas combustion turbines have efficiencies between 26% to 32% [5].

Some commentators point out that batteries are more efficient than fuel cells. This is correct when considering only the efficiency of producing electrical energy to drive the vehicle motor.

¹⁶ Natural gas is also used directly to fuel natural gas (internal combustion engine) vehicles; here too it is better to convert that natural gas to hydrogen at 75% efficiency for use in a FCEV with 2.4 times better fuel economy than an NGV. The net relative efficiency of the natural gas to hydrogen FCEV route compared to an NGV is $0.75 \times 0.93 \times 2.4 = 1.67$. The FCEV will consume 67% less natural gas energy than an NGV to travel the same distance.

Averaged over an aggressive driving cycle, the fuel cell system has a net efficiency of approximately 52% in converting hydrogen to electricity, while battery systems might be as high as 90% efficient in delivering electricity to the motor (the 10% or greater losses are due to internal battery resistance that cuts efficiency, particularly at high power draw, plus any parasitic losses such as thermal management of the battery stack). But one should consider the full system, not just one isolated component. Even though a battery is more efficient than a fuel cell when considered alone, the hydrogen and FCEV well-to-wheels system takes less total energy. This is due to the greater conversion efficiency of natural gas to hydrogen (as described above) and the fact that the battery EV is heavier than the FCEV for a given range. The battery EV requires more energy to travel a given distance, which cancels out much of the battery's efficiency advantage.¹⁷

This advantage of the fuel cell EV diminishes at shorter range as the battery EV becomes lighter. As shown in Figure 13, the efficiency of a battery EV with only 160 km (100 miles) range is almost

¹⁷ Note from Figure 12 that the heavy battery EV (1,899 kg) requires almost as much input energy (112 kWh) in the form of AC electricity as the fuel cell EV (137 kWh) needs in the form of hydrogen fuel to travel 400 km (250 miles), despite the higher efficiency of the battery system.

Fuel Cell and Battery Electric Vehicles Compared

identical to the total system efficiency of a fuel cell EV, assuming that the electricity is generated by a modern combined cycle turbine with 48% total system efficiency¹⁸.

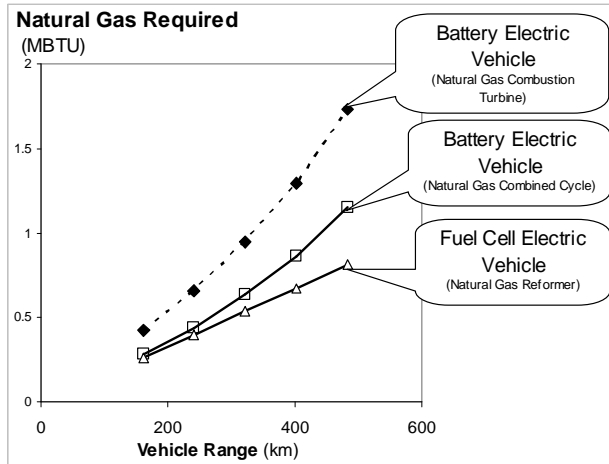

Figure 13. Quantity of natural gas required to power an advanced Li-ion battery EV using two different natural gas electricity generation systems compared to a hydrogen-powered fuel cell EV with hydrogen produced from natural gas

3.2. Biomass Utilization Efficiency

For the future, we need to shift to lower carbon sources for both electricity and hydrogen. One option is biomass. Which is more efficient: to convert biomass to electricity or to hydrogen? Figure 14 compares these two options.

Converting biomass to hydrogen uses 35% less energy than generating electricity for a battery EV to travel 400 km, which grows to 40% less biomass energy with 480 km vehicle range. As with natural gas, this advantage of fuel cell EVs decreases if both vehicle ranges are reduced to approximately 160 km (100 miles), as shown in Figure 15.

3.3. Wind Energy Utilization Efficiency & Incremental Cost

¹⁸ Advanced natural gas combined cycle plants have demonstrated 55% to as much as 60% efficiency. If these plants replace all older power plants in the future, the total system efficiency of the battery EV would equal that of the fuel cell EV at ranges of 320 km (200 miles) or less. By that time, however, hydrogen production may also shift to more energy-efficient pathways such as direct coal or biomass gasification (with carbon capture and storage in the case of coal).

Eventually society will produce significant intermittent renewable electricity from solar and wind turbines. Using this renewable electricity directly to charge EV batteries would be more efficient than converting that electricity to hydrogen for a FCEV, since the electrolysis step loses approximately 25% of the electrical energy and the battery is more efficient than the fuel cell. As shown in Figure 16, an advanced Li-ion battery EV would use about 40% less wind electricity (124 kWh) to travel 400 km (250 miles) than a hydrogen-powered fuel cell EV (207 kWh).

However, even with wind energy, a hydrogen-powered FCEV would have a life cycle cost (car plus fuel) advantage over the BEV from a total system perspective. Each FCEV would require the installation of slightly more wind turbine capacity to make up for the lower well-to-wheels efficiency of the wind-to-hydrogen-to FCEV pathway. There would also be incremental costs for the electrolyzer to produce the hydrogen, extra cost for hydrogen pipelines, compressors and hydrogen storage for each new FCEV added to the fleet. But the sum of the incremental FCEV cost plus all of these wind turbine and hydrogen fueling infrastructure incremental costs would be less than the incremental costs of a BEV plus the added costs of the charging system for each BEV. As shown in Figure 16, the incremental FCEV and infrastructure costs (\$7,700) would be less than half the incremental BEV and fueling costs (\$16,540).

In other words, for every 400 km (250 miles) of travel by a new FCEV added to the fleet, the energy company would have to install slightly larger wind turbines to provide 83.5 kWh of extra wind energy when the wind is blowing; slightly larger electrolyzers to make the extra hydrogen; a minutely larger pipeline network; and slightly larger compressors and storage tanks to accommodate the added load. Of course the energy company would make additions in much larger quantities, aggregating the load from hundreds or thousands of FCEVs. But the end result is that society would spend 53% less implementing a wind-to-hydrogen-to-FCEV pathway than implementing a wind-to-BEV pathway, assuming both vehicles were designed to travel 400 km. Figure 17 shows the incremental costs per vehicle as a function of range. If the battery EV was designed for only 160 km (100 miles) range, then the net cost of a FCEV plus the added wind and hydrogen infrastructure would cost more than a battery EV. For ranges greater than 225 km (140 miles), the incremental cost of the battery EV plus charging circuits would

Fuel Cell and Battery Electric Vehicles Compared

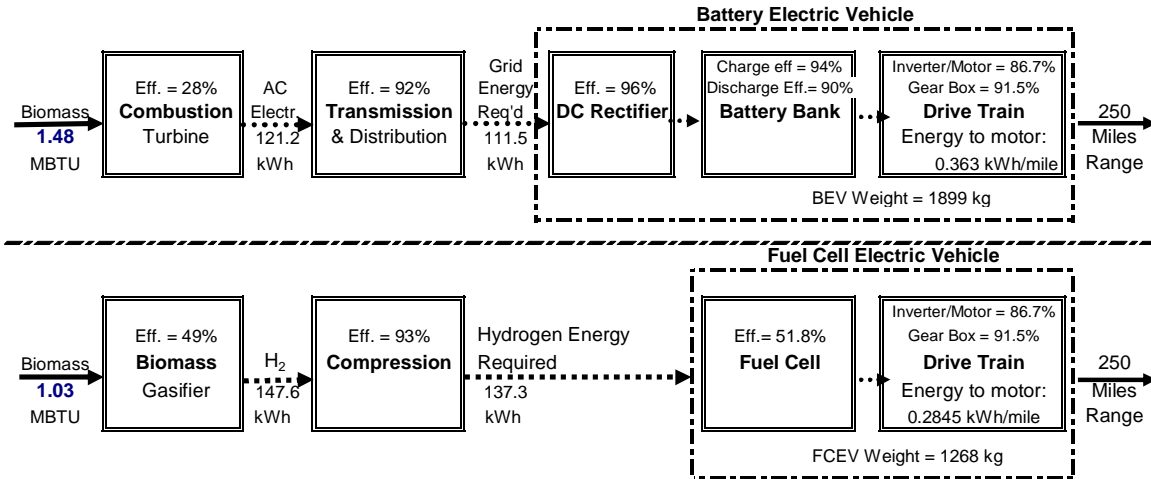

Figure 14. Full cycle energy efficiency of converting biomass to electricity to charge an advanced battery EV compared to converting biomass to hydrogen for a fuel cell EV, each with 400 km (250 miles) range; the hydrogen FCEV uses 35% less energy to travel 400 km

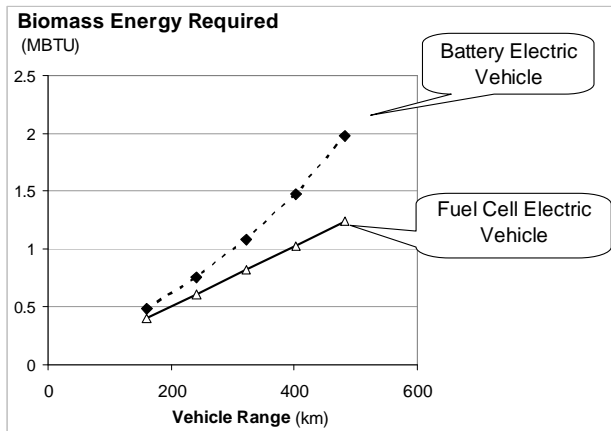

Figure 15 Biomass energy required for battery EVs and for fuel cell EVs as a function of vehicle range

be larger than the incremental costs of a FCEV plus its incremental wind turbine and hydrogen infrastructure costs. These incremental battery EV costs would rise rapidly above 240 km (150 miles) range, again showing that battery EVs with more than 320 km (200) miles range are not economic even when using advanced Li-ion batteries.

Stationary energy storage. If there were a large number of all-electric vehicles on the road running on intermittent wind or solar energy, there might be times when the hydrogen tanks or batteries on the vehicles being charged are full, and the need arises for stationary storage of excess renewable energy. Which is more economic: to store intermittent renewable electricity in stationary batteries when the grid is saturated and all BEV batteries plugged at that time are fully charged, or to store the excess renewable energy in the form of hydrogen?

Fuel Cell and Battery Electric Vehicles Compared

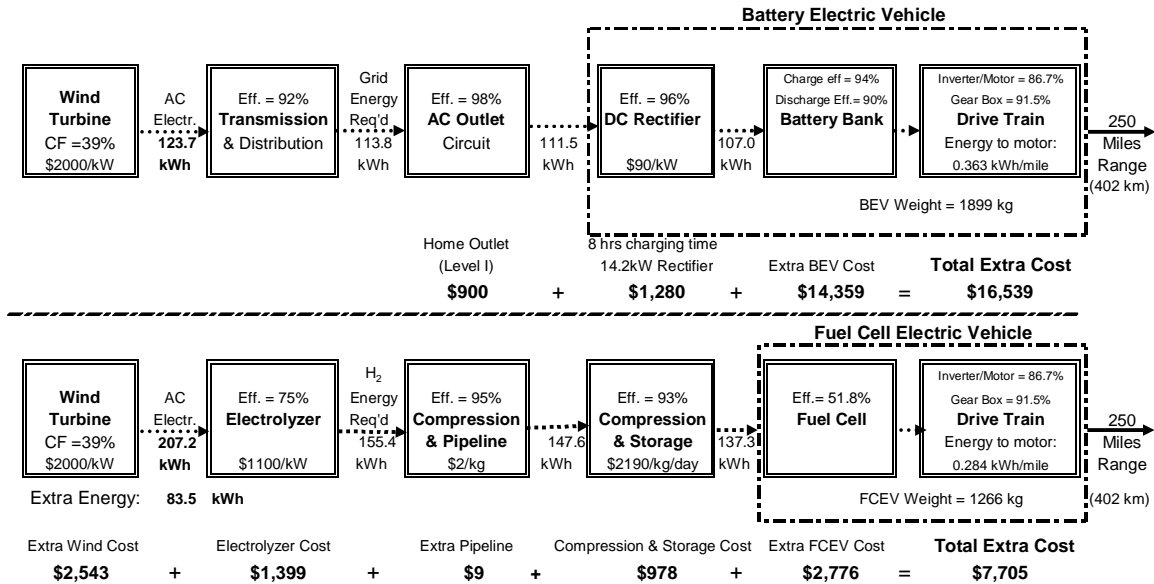

Figure 16. Estimated wind electrical energy and incremental societal cost for vehicle plus fuel infrastructure to support one advanced battery EV compared to one hydrogen-powered fuel cell EV, each traveling 400 km (250 miles) on energy derived solely from wind power

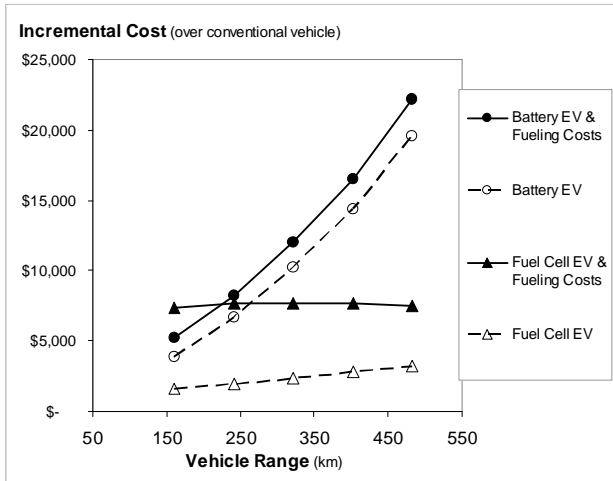

Figure 17. Incremental cost of battery EVs over conventional cars, plus the costs of charging circuits supplied by wind electricity, compared with the incremental costs of a fuel cell EV plus the incremental costs of wind turbines and hydrogen infrastructure to support one FCEV powered by wind electricity

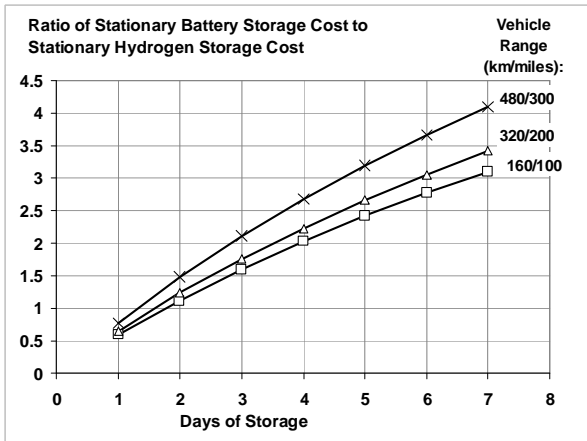

Figure 18 – Ratio of the cost of stationary battery storage to the cost of stationary hydrogen storage, both storing intermittent renewable energy and to account for variable demand for vehicle fuel as a function of the storage time required

Figure 18 shows the results in terms of the ratio of stationary battery storage cost to stationary hydrogen storage cost as a function of the days of storage required and the range of the vehicles¹⁹.

¹⁹ The range of the all-electric vehicles determines the ratio of electrical energy required for the BEV to the hydrogen energy required for the FCEV. For ranges of 160, 320 and 480 km, the BEV electricity required is

The hydrogen storage cost includes the cost of the necessary electrolyzer, compression system and hydrogen storage tanks²⁰. If the required storage time is less than approximately 36 hours, then stationary battery storage is more economical than hydrogen storage with the parameters used in this model. But if the sun doesn't shine or the wind doesn't blow appreciably for more than 36 hours, then hydrogen storage will cost less than stationary battery storage.

In addition to variability of the intermittent renewable electricity supply, there will also be variable demand for vehicle fuel that will require storage to fully utilize the renewable resource. Vehicle fuel may be needed more on week days than week ends. Demand for fuel may vary seasonally and there will always be a statistical variation in vehicle fuel use in any region. These variations in demand will contribute to the need for more storage, which will shift the balance in favor of hydrogen storage over battery storage.

Figure 18 is based on the premise that separate hydrogen compression and storage tanks will be required to store excess renewable electricity energy or to provide for variable demand. However, in a mature hydrogen economy utilizing hydrogen pipelines, these pipeline networks, unlike the electrical grid, will provide an inherent storage capability²¹. Electricity must be used immediately when it is produced. Hydrogen can be stored indefinitely, providing more flexibility when managing an intermittent resource like solar or wind. The previous calculation does not include this cost benefit of pipeline storage.

68%, 75% and 90% respectively of the hydrogen energy that needs to be stored.

²⁰ Cost assumptions include energy batteries at \$250/kWh; electrolyzers at \$1,100/kW of hydrogen flow; compressors at \$900/kW of hydrogen flow, hydrogen storage tanks at \$500/kg of stored hydrogen, with a wind capacity factor of 39% (which must also be the capacity factor of the electrolyzer and compressor).

²¹ For example, a 20 cm (7.9 inch) hydrogen pipeline 160 km long will store approximately 28,500 kg of hydrogen at 7 MPa (1,000 psi); if the inlet pressure of the station compressor can go down to 1.1 MPa (150 psi), then this pipeline could provide up to 23,000 kg of useable hydrogen storage, enough to supply 46,000 FCEVs for one day's operation in addition to any hydrogen added to the pipeline during that day.

4. Summary Comparison of Batteries and Fuel Cells

The advantages of the fuel cell EV are dominant if the battery EV must have 480 km (300 miles) range to serve as a fully functional all-purpose passenger vehicle²², but the fuel cell EV also has many superior attributes for EVs with only 320 km (200 miles) range as summarized in Table 3. These advantages are also plotted in Figure 19 as the ratio of the battery EV value to the fuel cell EV value for each attribute²³.

These advantages explain why most major automobile companies dropped their long-range battery all-electric vehicle developments in the 1990's and devoted most of their efforts to the fuel cell EV. While the car companies are now considering plug-in hybrids that require far less stringent battery characteristics than the all-electric EV, and while some car companies are developing short range battery-powered city cars for niche markets, the underlying benefits of the fuel cell have not changed.

²² Note that a 400-km (250-mile) or 480-km (300-mile) battery EV is too heavy and the batteries take up too much space for a practical passenger vehicle. These hypothetical BEV designs are used here solely to illustrate the impracticality of building a full-function, long range battery EV, compared to the fuel cell EV with the same functionality that is practical. .

²³ Fueling time ratios were too large to plot conveniently on this graph, since the long-range battery EV would take from 8 times to as much as 780 times longer to fuel than a hydrogen FCEV.

Fuel Cell and Battery Electric Vehicles Compared

Table 3. Summary of fuel cell EV attributes compared to those of the advanced battery EV for 320-and 480-km (200-mile and 300-mile) range

	320 km (200 miles) Range			480 km (300 miles) Range			
	Fuel Cell EV	Battery EV	Ratio BEV/FCEV	Fuel Cell EV	Battery EV	Ratio BEV/FCEV	
Vehicle Weight (kg)	1,259	1,648	1.31	1,280	2,214	1.73	
Storage Volume (Liters)	70 MPa	179	2.13	224		3.04	
	35 MPa	382	1.00	295	680	2.31	
Greenhouse Gases (g/km)	180	285	1.58	182	339	1.86	
Incremental Vehicle Cost (\$)	2,830	10,200	3.60	2,237	12,119	5.42	
Fuel Cost per km (cents/km) ^a	3.36	1.63	0.48	3.40	1.94	0.57	
Fueling Cost per Vehicle (\$)	955	878	0.92	955	2150	2.25	
Incremental Life Cycle Cost (\$)	13380	16187	1.21	14267	27734	1.94	
Natural Gas Req'd (MBTU)	NG CC ^b	0.53	1.19	0.81	1.15	1.42	
	NG CT		0.95	1.79		1.73	2.14
Biomass Req'd (MBTU)	0.82	1.09	1.33	1.24	1.98	1.60	
Wind Electricit Req'd (kWh)	164.9	90	0.55	250.1	165.4	0.66	
Wind + Vehicle Incremental Cost (\$)		7,712	12,041	1.56	7,510	22,215	2.96
	Level 1 ^c		43	645		78	780
	Level II ^d		0.07	11	165		190
	Level III ^e		0.55	8.25		1	10.00

- a) off-peak electricity = 6 cents/kWh; hydrogen = \$3.30/kg
- b) NG CC = natural gas combined cycle; NG CT = natural gas combustion turbine
- c) Level 1 residential charging = 120V, 20A single phase, 1.9 kW
- d) Level II charging = 240V, 40A, single phase, 7.7 kW
- e) Level III charging = 480V, 3-phase, 150 kW

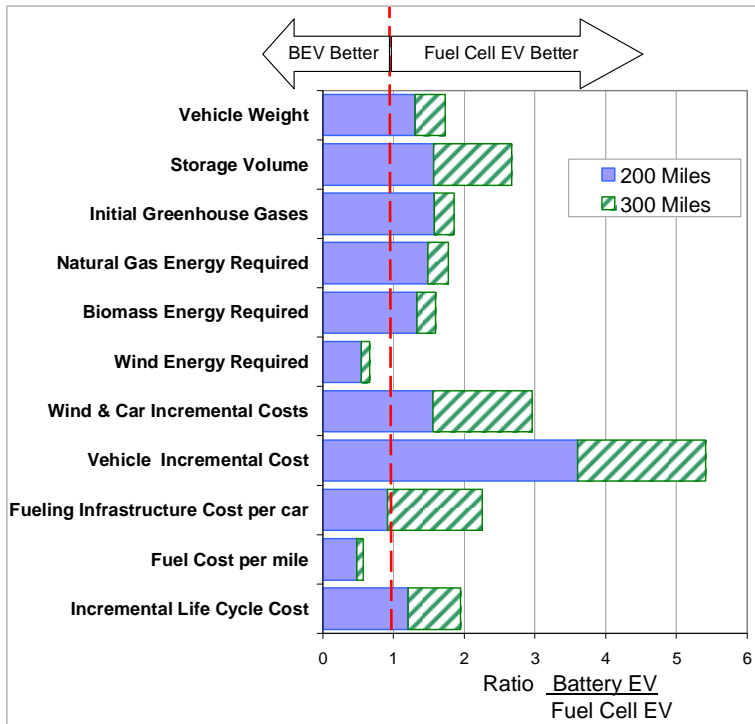

Figure 19. Ratio of advanced battery EV attribute divided by the fuel cell EV attribute for 320- and 480-km (200- and 300-mile) range, assuming average US grid mix in the 2010 to 2020 time period and all hydrogen made from natural gas (values greater than one indicate a fuel cell EV advantage relative to the battery EV)

We conclude that the fuel cell electric vehicle could provide the range, passenger and trunk space and refueling times at an affordable price demanded by modern drivers for full-function passenger vehicles. All-electric battery-powered electric vehicles will find niche applications as city cars and limited range commuter cars. A major breakthrough in battery technology, well beyond the US ABC battery goals, would be required before a long-range battery EV could satisfy customer's needs for conventional passenger cars, particularly with respect to battery recharging times. Most drivers would not accept more than 15 to 20 minutes charging time on long distance travel for EVs, while FCEVs can be refueled in the 3 to 5 minutes expected by consumers.

5. Conclusions

- To simultaneously reach our societal goals of a) an 80% reduction in greenhouse gases below 1990 levels in the light duty transportation sector, b) to eliminate almost all dependence

Fuel Cell and Battery Electric Vehicles Compared

on imported oil for transportation and c) to eliminate most local air pollution, we must transition most of the light duty vehicle fleet to all-electric-drive vehicles

- All-electric vehicles will be powered by either batteries (or possibly ultracapacitors) or by fuel cells with peak power augmentation batteries
- Fuel cell electric vehicles are superior to advanced lithium-ion full function battery electric vehicles, since the fuel cell EV:
 - Weighs less
 - Takes up less space on the vehicle
 - Generates less greenhouse gases in most of the US
 - Costs less (lower vehicle costs and life-cycle costs)
 - Requires less well-to-wheels natural gas or biomass energy
 - Takes much less time to refuel
- Battery electric vehicles have three advantages compared to fuel cell EVs:
 - Lower fuel cost per kilometer²⁴
 - Less well-to-wheels wind or solar energy per kilometer
 - Greater access to fueling capability initially

Acknowledgments

The author would like to thank Joan Ogden (then at Princeton) for her pioneering work first reported in 1989 that introduced this author to the renewable hydrogen field [12]. We would also like to thank the many people who have contributed over the years to the development and review of these vehicle simulation models, beginning with Ira Kuhn, Brian James, George Baum, Julie Perez and their colleagues at Directed Technologies, Inc.; Ron Sims, Brad Bates, Mujeeb Ijaz and colleagues (then at the Ford Motor Company); Bob Shaw (Arête); Barney Rush (CEO) and Frank Lomax (CTO) and all our co-workers at H₂Gen Innovations, Inc.; the financial support of the Department of Energy over many years and the contributions from DOE staff including, among others, Sig Gronich, Neil Rossmeissl, Steve Chalk, JoAnn Milliken, Pat Davis, Mark Paster, Fred Joseck, Tien Nguyen, Arlene Anderson and Rick Farmer; Joan Ogden

and Mark Delucchi and their colleagues at the University of California at Davis; Michael Wang, Amgad Elgowainy and colleagues at the Argonne National Laboratory; George Sverdrup and Marc Melaina at the National Renewable Energy Laboratory; Bob Rose at the US Fuel Cell Council; the National Hydrogen Association task force developing a new hydrogen energy story, the "Energy Evolution", headed by Frank Novachek of Xcel Energy; and a special thanks to Catherine Dunwoody at the California Fuel Cell Partnership for reading the final drafts and making numerous suggestions to improve the clarity and organization of some sections of this report.

²⁴ Although the fuel cost advantage requires off-peak electricity rates in the range of 6 cents/kWh and night-time charging, and even then is not enough to off-set the added capital cost of the battery EV compared to the fuel cell EV over the life of the vehicle.

References

1. Ramage MP, Chair, Committee on the Assessment of Resource Needs for Fuel Cell and Hydrogen Technologies, Transitions to Alternative Transportation Technologies—A Focus on Hydrogen, National Research Council of the National Academies, Washington, DC, 2008
http://books.nap.edu/catalog.php?record_id=12222#toc
2. Thomas CE. Comparison of Transportation Options in a Carbon-Constrained World: Hydrogen, Plug-in Hybrids and Biofuels. Proceedings of the National Hydrogen Association Annual Meeting, Sacramento, California, March 31, 2008.
3. The National Hydrogen Association. Energy evolution: an analysis of alternative vehicles and fuels to 2100. <http://www.hydrogenassociation.org/general/evolution.asp>
4. Sinha J, Lasher S, Yang Y, Kopf P. Direct hydrogen PEMFC manufacturing cost estimation for automotive applications. Fuel Cell Tech Team Review, September 24, 2008, Tiax LLC.
5. Duvall, M, Khipping E. Environmental assessment of PHEVs Vol 1 – National greenhouse gas emissions. Electric Power Research Institute/Natural Resources Defense Council Report # 1015325, July 2007
6. Wang MQ. Greenhouse gases, Regulated Emissions, and Energy use in Transportation. Argonne National Laboratory. [Argonne has also released version 2.8a that includes the impact of vehicle manufacturing <http://www.transportation.anl.gov/software/GREET/>]
7. Dhameja S. Electric Vehicle Battery Systems, Newnes Press, Boston 2002
8. Wipke K, Sprik S, Kurtz J, Ramsden T. Controlled hydrogen fleet and infrastructure demonstration and validation protect. National Renewable Energy Laboratory Report NREL/TR-560-45451, slide CDP#38, March 2009. <http://www.nrel.gov/hydrogen/pdfs/45451.pdf>
9. Morrow K, Karner D, Francfort J. Plug-in hybrid electric vehicle charging infrastructure review. Final Report INL/EXT-08-15058, Idaho National Laboratory, November 2008
10. Kromer M, Heywood J. Electric powertrains: opportunities and challenges in the U.S. light-duty vehicle fleet. Sloan Automotive Laboratory, Massachusetts Institute of Technology, Publication No. LFEE 2007-03 RP, May 2007.
11. Annual Energy Outlook, U.S. Department of Energy, Energy Information Administration Report # DOE/EIA 0383 (2009), <http://www.eia.doe.gov/oiaf/aeo/index.html>
12. Ogden J, Williams R. Solar hydrogen: moving beyond fossil fuels. World Resources Institute, October 1989.

*Corresponding author. Tel.:703-461-7657;

E-mail address: thomas@cleancaroptions.com

This article was published in the International Journal of Hydrogen Energy 34 (2009) 6005-6020

doi:10.1016/j.ijhydene.2009.06.003